

1.

LIGHT DEPENDENT RELAYS

PURPOSE

Light dependent relay serves to switch-ON the lighting of streets, squares, shop windows, neon lamps etc, at twilight and to switch-OFF afore mentioned lighting at dawn.

FUNCTIONING

The relay should be situated at place with permanent access to day light, which, due to its changes of intensity, will cause switching ON and OFF the lighting. The exact time of switching the lighting can be set by potentiometer by the user. Turn in the direction of "half moon" will delay switching-ON, turning in the direction of "sun" will advance switching-ON. The relay is equipped with a delay system, which delays switching ON and OFF the lighting, thus eliminating the influence of accidental disturbances like thunder lightings on the relay functioning.

WITH INTERNAL LIGHT DEPENDENT SENSOR

AZH

10A. Hermetic.

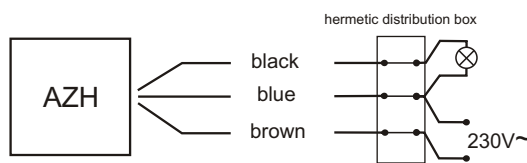

supply	230V AC
current load	<10A
switching threshold (setting range)	2÷1000Lx
switching threshold (factory setting)	ok. 7Lx
hysteresis	ok. 15Lx
switching ON delay	1÷15sec
switching OFF delay	10÷30sec
power consumption	0,56W
connection cable	3×0,75mm ² ; l=0,8m
working temperature	-25÷50°C
dimensions	50×67×26mm
fixing	two screws to substrate
protection level	IP65

AZH-106

16A. Hermetic.

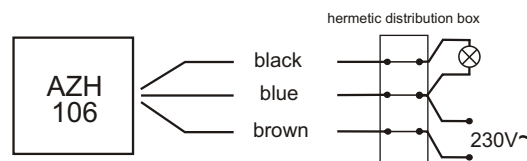

supply	230V AC
current load	<16A
switching threshold (setting range)	2÷1000Lx
switching threshold (factory setting)	ok. 7Lx
hysteresis	ok. 15Lx
switching ON delay	1÷15sec
switching OFF delay	10÷30sec
power consumption	0,56W
connection cable	3×1mm ² ; l=0,8m
working temperature	-25÷50°C
dimensions	50×67×26mm
fixing	two screws to substrate
protection level	IP65

AZH-C

10A. Miniature. Hermetic.

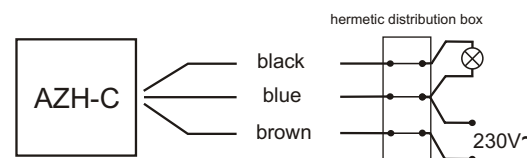

supply	230V AC
current load	<10A
switching threshold (setting range)	2÷1000Lx
switching threshold (factory setting)	ok. 7Lx
hysteresis	ok. 15Lx
switching ON delay	1÷15sec
switching OFF delay	10÷30sec
power consumption	0,56W
connection cable	3×0,75mm ² ; l=0,5m
working temperature	-25÷50°C
dimensions	81×33×25mm
fixing	two screws to substrate
protection level	IP65

AWZ 16A. Hermetic. With internal connection.
AWZ-30 30A. Hermetic. With internal connection.



Light dependent relay in box with special sealing flange, fastened to the substrate by two screws, closed by a cover with silicon gasket and tightened by 4 screws.

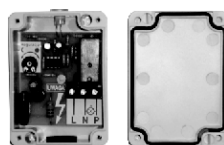
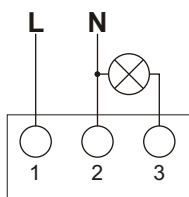

supply	230V AC
current load	<16A
switching threshold (setting range)	2+1000Lx
switching threshold (factory setting)	ok. 7Lx
hysteresis	ok. 15Lx
switching ON delay	1+15sec
switching OFF delay	10+30sec
power consumption	0,8W
connection	screw terminals 2,5mm ²
working temperature	-25+50°C
dimensions	60x85x35mm
fixing	two screws to substrate
protection level	IP65

WITH EXTERNAL HERMETIC PROBE

AZH-S / AZH-S PLUS

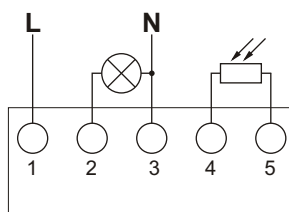

External hermetic probe Ø10 or PLUS (see item 1/9) including with automatic twilight sensor.

supply	230V AC
current load	<16A
switching threshold (setting range)	2+1000Lx
switching threshold (factory setting)	ok. 7Lx
hysteresis	ok. 15Lx
switching ON delay	1+15sec
switching OFF delay	10+30sec
power consumption	0,56W
connection	screw terminals 2,5mm ²
working temperature	-25+50°C
dimensions	50x67x26mm
fixing	two screws to substrate

AZ-B / AZ-B PLUS

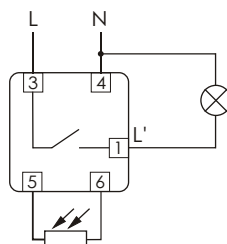

External hermetic probe Ø10 or PLUS (see item 1/9) including with automatic twilight sensor.

supply	AZ-B / AZ-B PLUS 230V AC
	AZ-B UNI / AZ-B PLUS UNI 12+264V AC/DC
current load	<16A
switching threshold (setting range)	2+1000Lx
switching threshold (factory setting)	ok. 7Lx
hysteresis	ok. 15Lx
switching ON delay	1+15sec
switching OFF delay	10+30sec
power consumption	0,56W
connection	screw terminals 2,5mm ²
working temperature	-25+50°C
dimensions	2 modules (35mm)
fixing	on rail TH-35

AZ-112 / AZ-112 PLUS

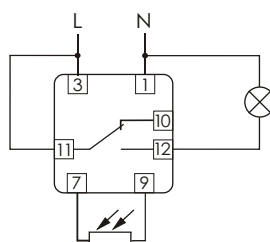

External hermetic probe Ø10 or PLUS (see item 1/9) including with automatic twilight sensor.

supply	230V AC
contact	1N/O
current load	<16A
switching threshold (setting range)	2+1000Lx
switching threshold (factory setting)	ok. 7Lx
hysteresis	ok. 15Lx
switching ON delay	1+15sec
switching OFF delay	10+30sec
power consumption	0,8W
connection	screw terminals 2,5mm ²
working temperature	-25+50°C
dimensions	1 module (18mm)
fixing	on rail TH-35

Hermetic external probe

PLUS

Applied in sets: AZH-S PLUS, AZ-B PLUS, AZ-112 PLUS.
Available separately.

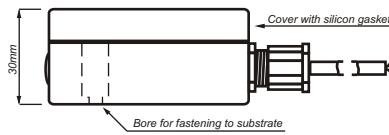
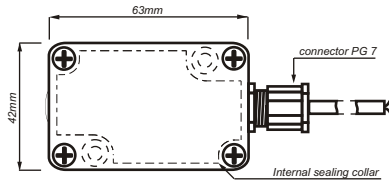

Optical sensor in convenient low dimensioned casing, to be connected by connector PG7 with round cable $\varnothing_{max} 7$ mm, (for ex. $2 \times 0,5 \text{mm}^2$) of length acc to necessity, Box with special sealing flange, fastened to the substrate by two screws, closed by a cover with silicon gasket and tightened by 4 screws.

Ø10

Applied in sets: AZH-S, AZ-B, AZ-112.
Available separately.

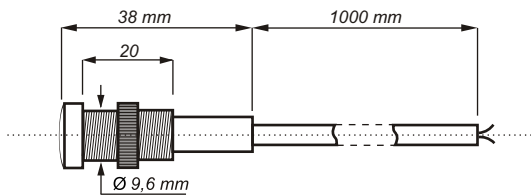

Little, easy to mount light dependent sensor with 1 meter cable with possibility to extend (connection of leads should be made in hermetic distribution box or at a place free from atmospheric influence).

ATTENTION!

The external probe should be situated at place with permanent access to day light, which, due to its changes of intensity, will cause switching ON and OFF the lighting.
When length of connecting cable of external probe exceeds 10m it should not be laid in vicinity of a parallel conductor under mains voltage, or conducting great currents. In any case always connect correctly phase and neutral leads to the light dependent relay.

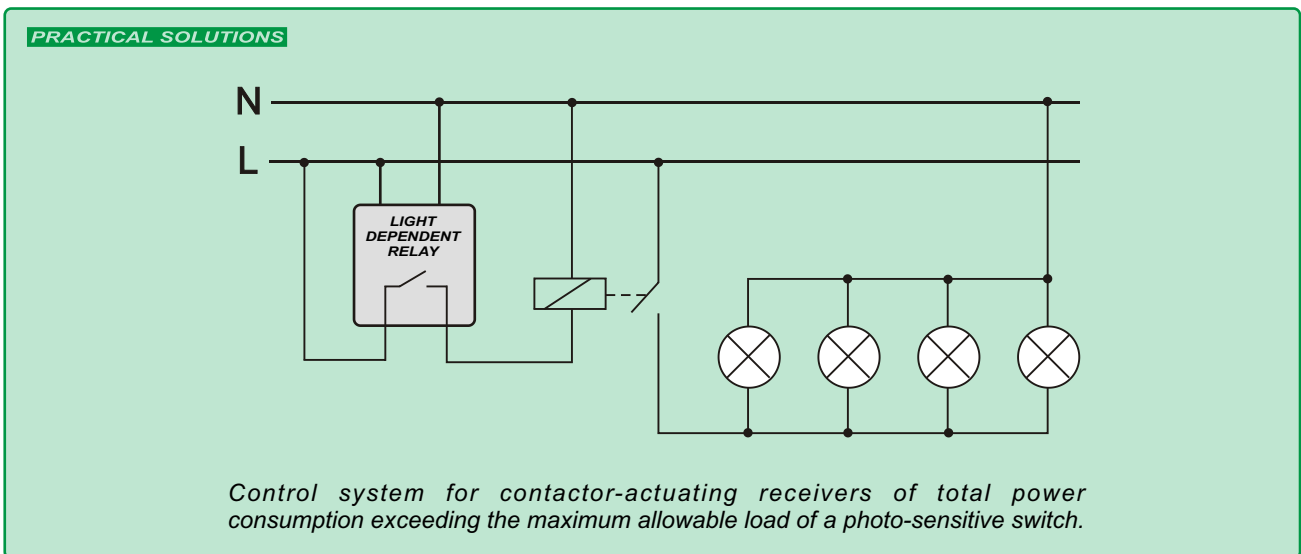

ATTENTION!

Automatic twilight sensors for other voltages than specified in the technical data table are also available on special request (24V, 48V, and 110V AC/DC and other).