

24. TEMPERATURE REGULATORS

PURPOSE

Temperature regulators may be used for equipment control in anti-freeze systems which prevent the freezing of gutters, the accumulation of ice on stairs, vehicles, etc.

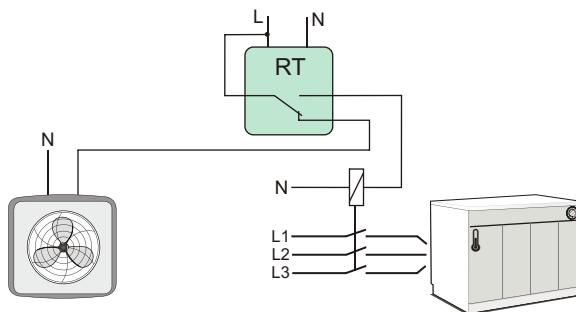

- RT-820** temperature setting range: 4÷30°C
- RT-821** emperature setting range: -4÷5°C
- RT-822** emperature setting range: 30÷60°C
- RT-823** emperature setting range: 60÷95°C

FUNCTIONING

The power supply to the generator is indicated by the green LED. Until the required ambient temperature is achieved, the contact of the regulator remains in position 2-1 and the heating device is active. Once the set value is achieved, the contact shifts into position 2-8 and the heating or ventilation device is turned off. Any drop in temperature by the hysteresis value will activate the heating device again (contacts 2-1 closed) until the set temperature value is achieved.

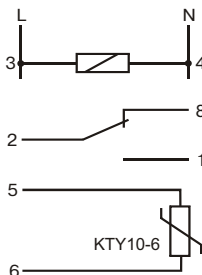

supply	230V AC
current load	<16A
contact	1 C/O
temperature setting range	
RT-820	4+30°C
RT-821	-4+5°C
RT-822	30+60°C
RT-823	60+95°C
hysteresis setting range	0,5+3°C
temperature sensor	KTY 10-6
length of probe with sensor	2,5m cable
power supply indicator	green LED
operation mode indicator	yellow LED
power consumption	1,1W
terminal	screw terminals 2,5mm ²
dimensions	2 modules (35mm)
fixing	on rail TH-35

PROBE RT for RT-820, RT-821, RT-822

PROBE RT823 for RT-823



temperature sensor	KTY 10-6
dimansion	Ø5; h=20mm
isolation of sensor	PC
cable	PC 2×0,34mm ² ; l=2,5m



temperature sensor	KTY 10-6
dimansion	Ø8; h=40mm
isolation of sensor	brass muff
cable	heatresist SIHF 2×0,5mm ² ; l=2,5m

FOR HOME APPLICATIONS

RT-824 temperature range: 5÷35°C

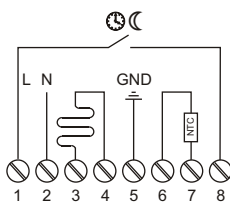

supply	230V AC
current load	<16A
contact	1 NO
temperature setting range	5÷35°C
hysteresis setting range	3°C
set value accuracy	±1°C
temperature sensor	NTC
length of probe with sensor	3m cable
power consumption	0,8W
terminal	screw terminals 1,5mm ²
dimensions	
front	83,5×83,5mm; gt.22mm
back	Ø50; gt.27,5mm
fixing	to under plaster box Ø60mm

FUNCTIONS

- * possibility of programming 1 required temperature
- * the knob located on the front panel enables setting a required temperature
- * the breaker switch located on the front panel enables switching off the power supply of the whole heating system
- * the input for connecting a control clock
- * signalling of the heating system activation
- * 2 temperature sensors: an internal one and an external one
- * 3 operation modes of the regulator: operation with the internal temperature sensor; operation with the external temperature sensor; operation with two temperature sensors
- * in the mode of operation with the internal temperature sensor: in case of the failure of the temperature sensor the regulator will shift to the so-called safe automatic model and will try to maintain the temperature set
- * automatic switching over to the mode of operation with the internal temperature sensor in case of a failure of the external sensor
- * in the mode of operation with two temperature sensors, the external sensor is the limiting one and it does not permit the temperature of 27°C to be exceeded regardless of the temperature set by means of the temperature adjusting knob
- * in the mode of operation with two temperature sensors: if both temperature sensors fail, the regulator will shift to the so-called safe automatic model. Working with interruptions, the regulator will try to maintain the temperature at the level of 80% of the set temperature.

RT-825 temperature range: 5÷60°C

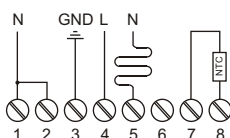
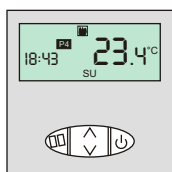

supply	230V AC
current load	<16A
contact	1 NO
temperature setting range	5÷60°C
hysteresis setting range	0÷10°C
set value accuracy	±1°C
temperature sensor	NTC
length of probe with sensor	3m cable
power consumption	0,8W
terminal	screw terminals 1,5mm ²
dimensions	
front	83,5×83,5mm; gt.22mm
back	Ø50; gt.27,5mm
fixing	to under plaster box Ø60mm

FUNCTIONS

- * the control panel enables programming and monitoring the device operation
- * the breaker switch located on the front panel enables switching off the power supply of the whole heating system
- * maintaining a preset temperature in accordance with programmed hours and days of the week
- * possibility of programming 4 intervals of a required temperature per 24 hours
- * 12 program entries: 4 entries concerning the required temperature for working days (Pn-Pt: Monday through Friday); 4 entries concerning the required temperature for Saturday (So: Saturday) and 4 entries concerning the required temperature for Sunday (Nd: Sunday)
- * possibility of a quick, manual correction of the currently maintained temperature
- * adjustable hysteresis
- * 2 temperature sensors: an internal one and an external one
- * 3 operation modes of the regulator: operation with the internal temperature sensor; operation with the external temperature sensor; operation with two temperature sensors
- * in the mode of operation with two temperature sensors, the external sensor is the limiting one with an adjustable temperature within the range of 15÷50°C

PROBE for RT-824, RT-825



temperature sensor	NTC
dimension	Ø7; h=25mm
isolation of sensor	PC muff
cable	PC 2×0,34mm ² ; l=3m

PROGRAMMABLE

PURPOSE

The CRT controllers are multi-function, programmable electronic devices which enable control of heating or cooling devices in order to maintain a stable room temperature, as well as to control ambient and substance temperatures in industrial conditions, with the option of supervising technological processes.

FOR HOME APPLICATIONS

CRT-04 temperature range: 0÷60°C

FUNCTIONING

The operation time and required temperature are achieved according to the individual program set by the user. The CRT controllers are equipped with a calendar and a real time clock which enable switching the controlled device on and off at preset hours within the following cycles: 24-hour, weekly, business-day (Mon. Fri.) or weekend (Sat., Sun.).

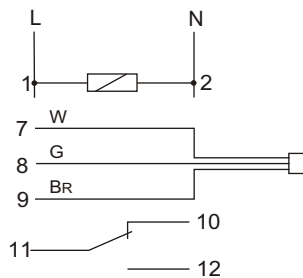
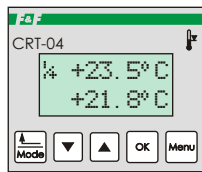

supply	230V AC
current load	<16A
contact	1 C/O
temperature setting range	0÷60°C
hysteresis setting range	0÷10°C
set value accuracy	0,1°C
model correction	±5°C
lagged switching - regulated	1÷15min
type of temperature sensor	RT4
length of probe with sensor	2,5m cable
power consumption	1,5W
terminal	screw terminals 2,5mm ²
dimensions	3 modules (52,5mm)
fixing	on rail TH-35

CONTROLLER'S FEATURES:

- *control panel for programming and monitoring;
- *operation modes: HEATING and COOLING to maintain a preset temperature according to programmed hours and days;
- *CONTINUOUS operating mode to maintain a single preset temperature value while ignoring other program entries;
- *MEASUREMENT operating mode display of an actual temperature value without controlling a connected machine;
- *50 program entries;
- INTERVAL this feature enables the user to program up to 8 required temperature values (3 in the MY1, MY2 and MY3 modes, and an additional 5 in modes called MORNING, WORK, DINNER, DAY, and NIGHT for everyday time windows related to the users' lifestyle;
- *DELAY programmable time of response delay while exceeding limit temperature values;
- *CORRECTION related to the temperature read-out error against the model thermometer;
- *SENSORS visual signalisation of the temperature sensor failure;
- *DST automatic DST time implementation with programmable shift to manual mode;
- *LIGHT selection of display illumination mode.
- *LANGUAGE program menu in three languages: Polish, English or Russian

Menu (example)

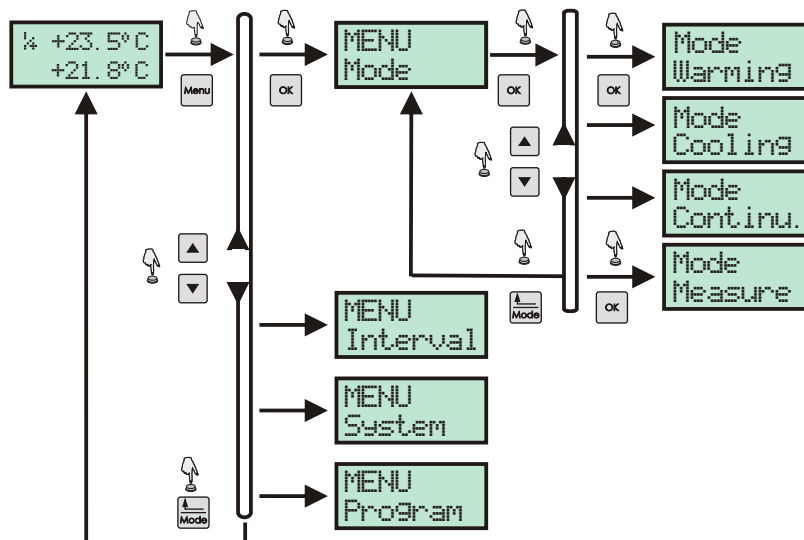

**INDUSTRIAL
FUNCTIONING**

The controller responds to a selected function on the basis of individual entries concerning parameters like temperature, hysteresis, response delay, and other values preset by the user.

CRT-05 2-FUNCTION temperature range: -100÷400°C

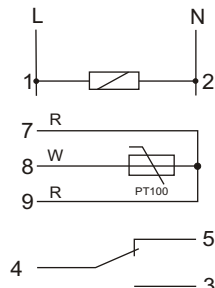
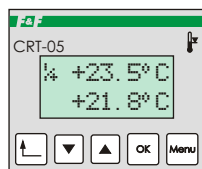

supply	230V AC
current load	<16A
contact	1 C/O
temperature setting range	-100÷400°C
hysteresis setting range	0÷100°C
set value accuracy	1°C
model correction	±20°C
lagged switching - regulated	0÷45min
gradient - regulated	4°C/1sec
type of temperature sensor	PT100
power consumption	1,5W
terminal	screw terminals 2,5mm ²
dimensions	3 modules (52,5mm)
fixing	on rail TH-35

CONTROLLER'S FEATURES:

- *control panel for programming and monitoring;
- *2 operations modes: HEATING and COOLING
- *2 regulated HYSTERESIS values lower and upper limits;
- *AUTOMATIC mode operation with one selected function;
- *MANUAL mode permanent closing or opening of the contact without a temperature measurement.
- *CORRECTION related to the temperature read-out error against the model thermometer;
- *WARNING - visual signalisation of the temperature sensor failure, range exceed and speed rising or falling temperature exceed
- *limiting access to program menu using PIN code
- *LIGHT selection of display illumination mode.
- *LANGUAGE program menu in three languages: Polish, English or Russian

HEATING

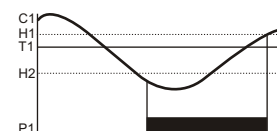

COOLING

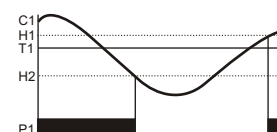

CRT-06 10-FUNCTION temperature range: -100÷400°C

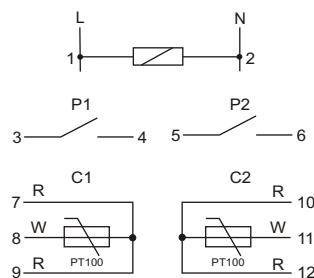
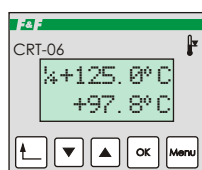

supply	230V AC
current load	2x(<16A)
contact	1 C/O
temperature setting range	-100÷400°C
hysteresis setting range	0÷100°C
set value accuracy	1°C
model correction	±20°C
lagged switching - adjustable	0÷45min
gradient - regulated	4°C/1sek÷6°C/1min
sampling frequency - regulated	1÷120probek/1min
type of temperature sensor	PT100
power consumption	1,5W
terminal	screw terminals 2,5mm ²
dimensions	3 modules (52,5mm)
fixing	on rail TH-35

CONTROLLER'S FEATURES:

- *control panel for programming and monitoring;
- *10 operation functions;
- *2 independent temperature sensors;
- *two independent temperature values may be set;
- *2 x 1P contacts applied to the temperature sensors;
- *2 hysteresis set values, one for each sensor;
- *AUTOMATIC mode - operation with one selected function;
- *MANUAL mode permanent closing or opening of the contact without a temperature measurement. Separate temperature drops for the P1 and P2 contacts.
- *memory feature for maximum and minimum temperature values registered, independent for the C1 and C2 sensors;
- *CORRECTION related to the temperature read-out error against the model thermometer;
- *WARNING - visual signalisation of the temperature sensor failure, range exceed and speed rising or falling temperature exceed
- *limiting access to program menu using PIN code
- *LIGHT selection of display illumination mode.
- *LANGUAGE program menu in three languages: Polish, English or Russian

OPERATIONAL FUNCTIONS OF THE CRT-06

PROG 1

HEATING mode. The P1 and P2 contacts depend on the C1 sensor.

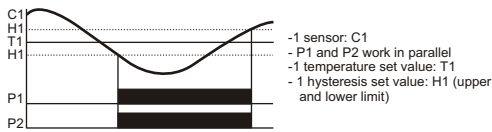

PROG 2

COOLING mode. The P1 and P2 contacts depend on the C1 sensor.

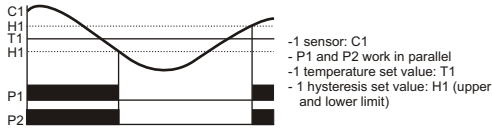

PROG 3

HEATING / COOLING modes. The P1 and P2 contacts depend on the C1 sensor.

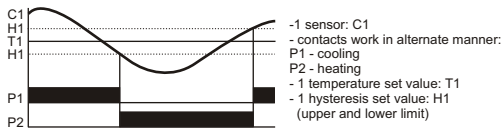

PROG 4

For contacts P1 and P2. The P1 contact dependent on the C1 sensor, the P2 on the C2 sensor.

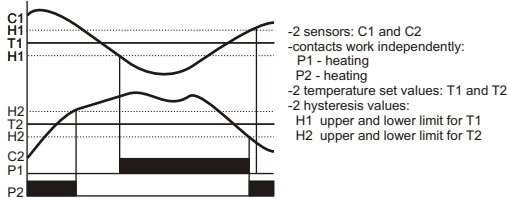

PROG 5

COOLING mode for the P1 and P2 contacts. The P1 contact depends on the C1 sensor, the P2 on the C2 sensor.

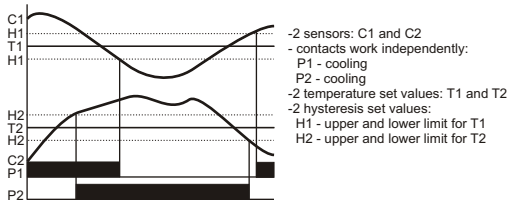

PROG 6

HEATING mode for the contacts P1 and P2. The P1 contact depends on the C1 sensor, and the P2 on the C2 and C1 (activated only with the P1 contact closed).

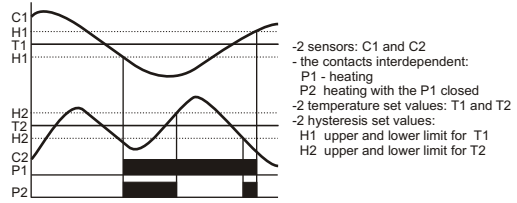

PROG 7

DIFFERENTIAL mode. The P1 contact closed with the temperature difference exceeding the set value. The P2 contact activated in the reversed conditions in comparison to the P1, i.e. with the temperature difference lower than the set value.

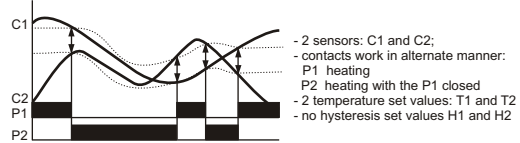

PROG 8

WINDOW mode. The P1 and P2 contacts closed when the C1 sensor temperature is between the preset temperature values of T1 and T2.

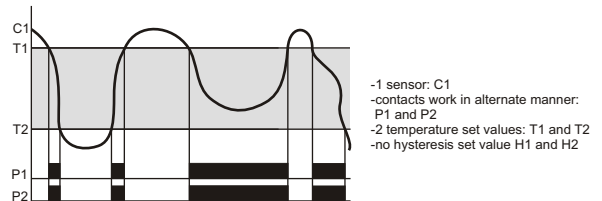

PROG 9

WINDOW mode. The P1 and P2 contacts closed when the C1 and C2 sensors temperature is between the preset temperature values of T1 and T2.

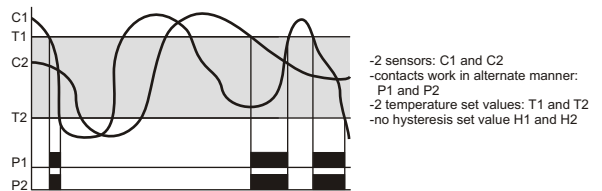

PROG 10

WINDOW mode independent for the P1 and P2 contacts. The P1 contact closed when the C1 sensor temperature is between the preset temperature values of T1 and T2. The P2 contact closed when the C2 sensor temperature is between the preset temperature values of T3 and T4.

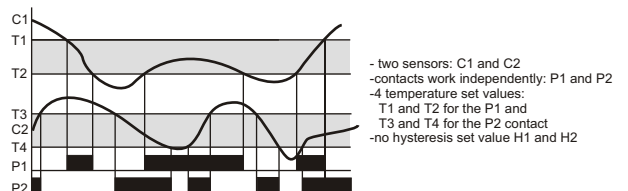

PROBE RT4 for CRT-04



temperature sensor	DS18S20
dimension	Ø5; h=30mm
isolation of sensor	PC
cable	LiYY 3×0,34mm ² l=2,5m

PROBE PT100 for CRT-05, CRT-06



temperature sensor	PT100
dimension	Ø4; h=85mm
isolation of sensor	steel muff
cable	PC 3×0,34mm ² ; l=1,5m
	in metal braid sheath

CRT-15T *temperature range: 0÷400°C*

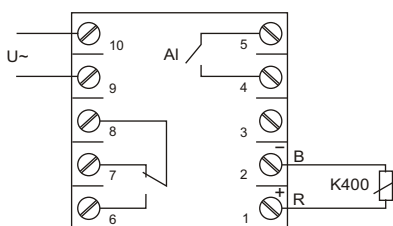

supply	100÷240V
current load	<3A
contact	1 C/O
load current for alarm output	<1A
alarm output contact	1 NO
temperature setting range	0÷400°C
PID set value	
proportional section P	0÷100
integrating section I	0÷255
differentiating section D	0÷255
set value accuracy	0,5°C
model correction	±15°C
lagged switching - regulated	0÷45min
gradient - regulated	4°C/1sec
type of temperature sensor	K400
power consumption	1W
terminal	screw terminals 2,5mm ²
dimensions	48×48×86

CONTROLLER'S FEATURES:

- *control panel for programming and monitoring of device operation;
- *PID controller (a proportional-integral-derivative controller);
- *automatic tuning of the PID regulator;
- *ALARM programmable temperature limit to trigger off the alarm feature;
- *preset temperature indications;
- *current temperature indications;
- *1P output contact;
- *additional ALARM output: 1Z contact
- *CORRECTION related to the temperature read-out error against the model thermometer;
- *LOCK settings block.

PROBE for CRT-15T



temperature sensor	K400
dimansion	thread M6; h=15mm
isolation of sensor	steel
cable	2×0,34mm ² l=1,0m in steel weave

RESISTANCE (THERMAL) RELAY

CR-810 TO CO-OPERATION WITH THE PTC THERMISTOR-EQUIPPED TEMPERATURE SENSORS.

PURPOSE

The resistance relay protects electrical equipment against any undesirable temperature increases by means of PTC resistors in serial connection (1-6 pieces).

FUNCTIONING

Correct operation (closed contacts 3-7) is indicated by the green LED (correct power voltage, temperature of the controlled device, working circuit of connected PTC sensors). The increase in temperature of at least one sensor over the rated value results in an increase in its resistance over 3000Ω. The relay is then activated (contacts 3-7 open). The system is activated automatically if the resistance of the PTC sensor loop decreases below the threshold of 1800Ω (drop in temperature of the controlled device). The contact of the executive relay also opens in the event of the resistance dropping to 15Ω (e.g. during a short circuit between cables) or with the power voltage turned off.

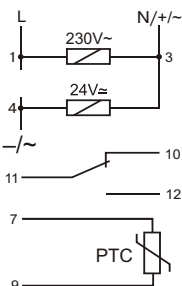
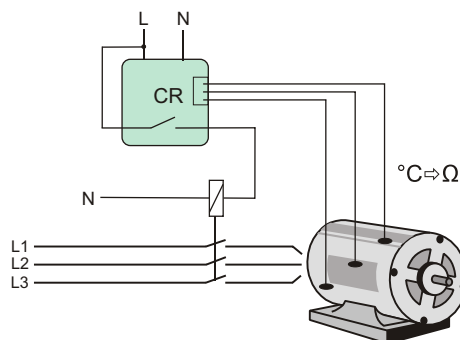

supply	230V AC / 24V AC/DC
current load	<16A
contact opening resistance	R>3000Ω, R<70Ω
contact closure resistance	110Ω<R<1800Ω
max resistance of sensor loop when cold	R=1500Ω
power supply / correct conditions indicator	green LED
damage conditions indicator	2×red LED
working temperature	-25÷50°C
terminals	screw terminals 2,5 mm ²
dimensions	1 module (18 mm)
fixing	on rail TH-35